

Lid Upper

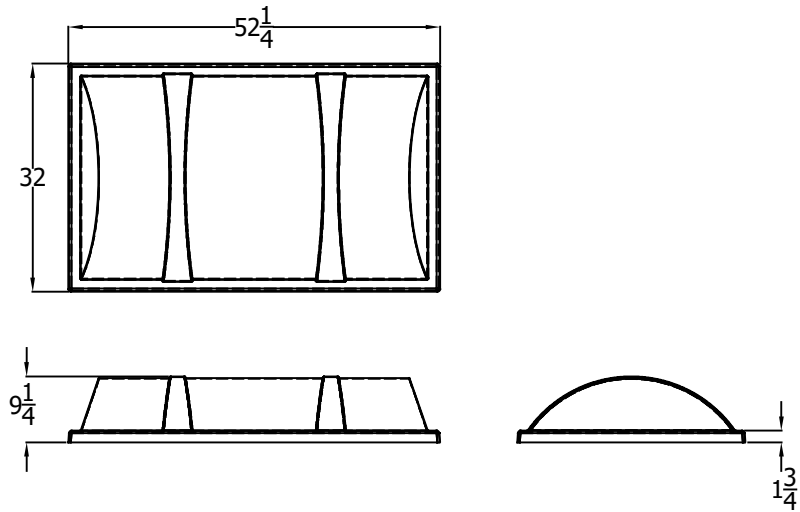

551 Dock Box

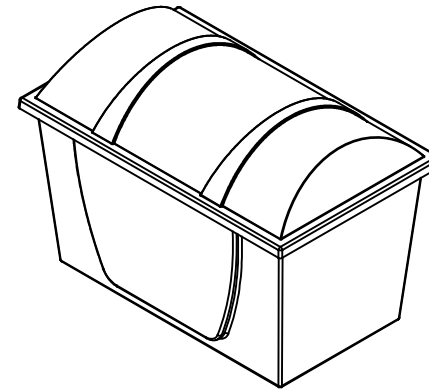

Box Bottom

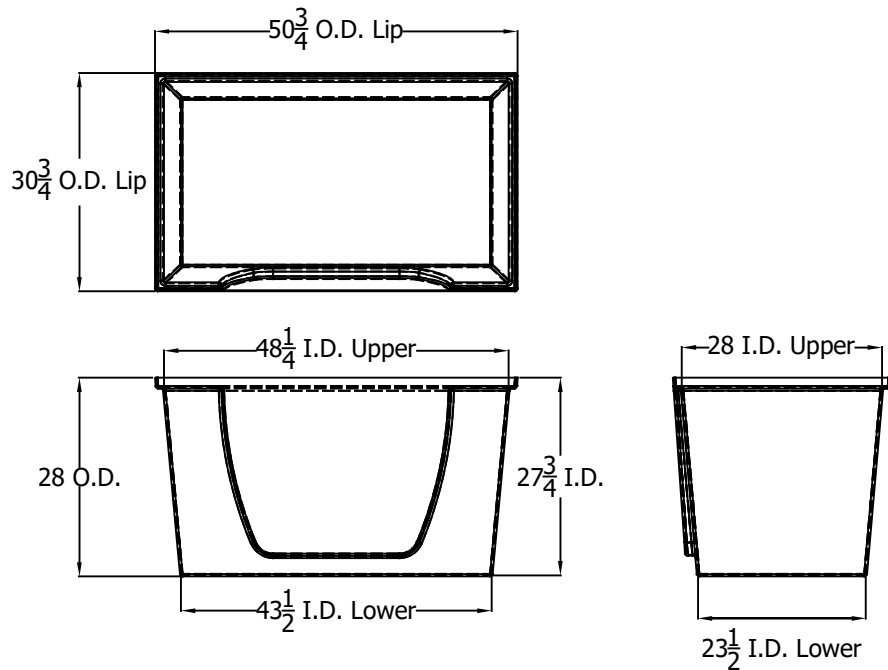

Lid with Box

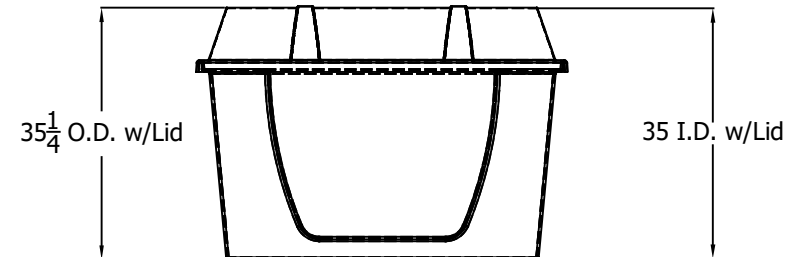

UNLESS OTHERWISE SPECIFIED:

DIMENSIONS ARE IN INCHES
TOLERANCES:
FRACTIONAL $\pm \frac{1}{16}$ "
ANGULAR: MACH $\pm 1^\circ$ BEND $\pm 1^\circ$
TWO PLACE DECIMAL $\pm .06$
THREE PLACE DECIMAL $\pm .03$

PROPRIETARY AND CONFIDENTIAL
THE INFORMATION CONTAINED IN THIS
DRAWING IS THE SOLE PROPERTY OF DOCK
BOXES UNLIMITED, INC. ANY REPRODUCTION
IN PART OR AS A WHOLE WITHOUT THE
WRITTEN PERMISSION OF DOCK BOXES
UNLIMITED, INC. IS PROHIBITED.

DESCRIPTION:

551 Dockbox

PART NO.

551 Dockbox

DRAWN BY

JJW

SCALE 1:1

REV

-

09/27/19

SHEET 1 OF 1