

REVISED	DATE	BY

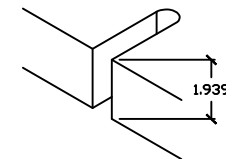
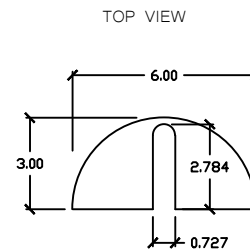
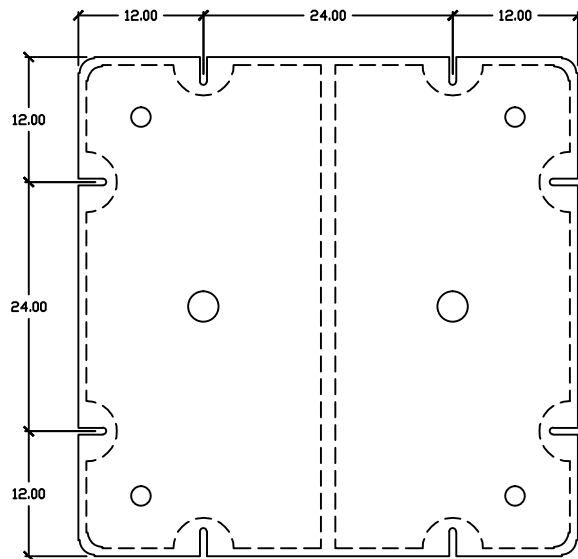
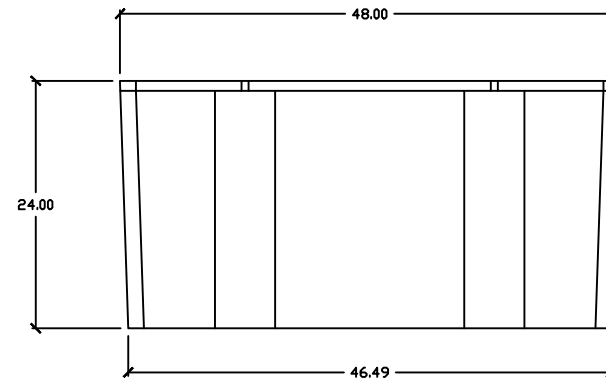
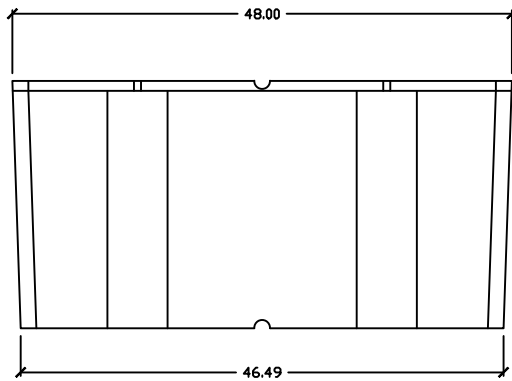

MOUNTING SLOT DETAIL  
SCALE 2:1

ALL DIMS NOMINAL

Common technical specs.

Max buoyancy :	1680 LB'S
Nominal wall thickness :	0.15"
Cubic feet:	32.0 FT³
Weight:	78.0 LB.'s

As with all types of materials, allowances must be made for shrinkage and changing of exact dimensions due to temperature and other conditions.

DRAWN BY JEB	APPROVED BY	DATE: 06-20-2014
Materials: Polyethylene encasing Expanded Foam		Type:
Part Name: 4'x4'x24"		
AutoCad 2010	PART # : EF4424	1 of 1