

REVISED	DATE	BY

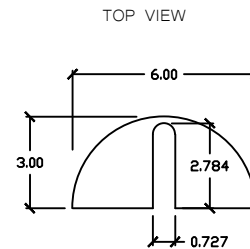

MOUNTING SLOT DETAIL
SCALE 2:1
ALL DIMS NOMINAL

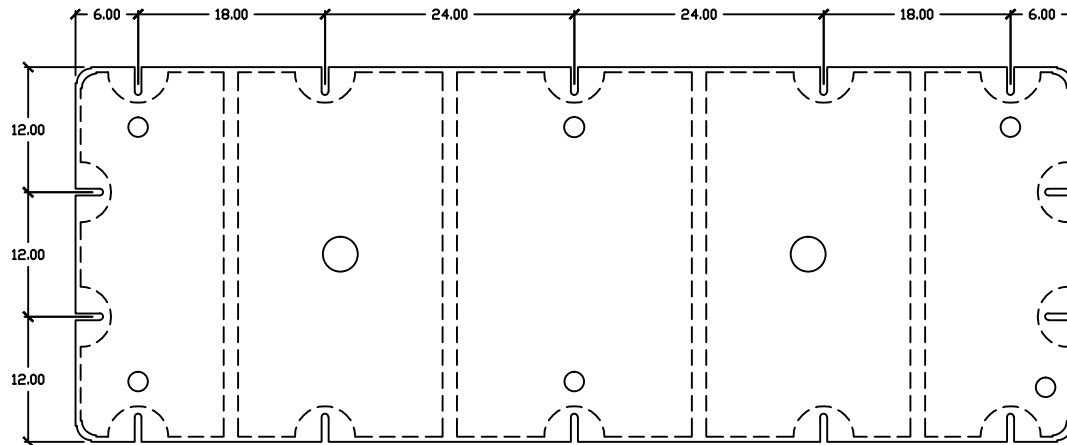
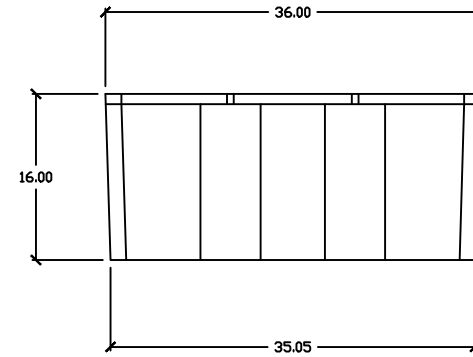
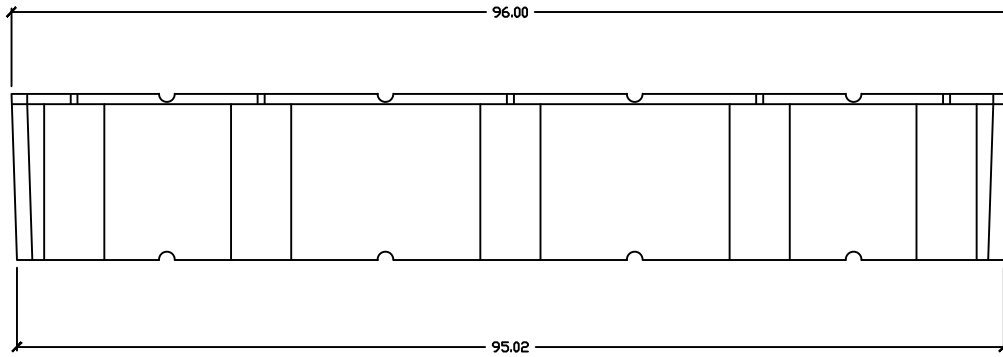
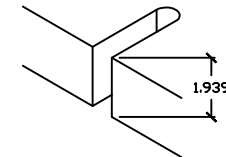

Common technical specs.		
Max buoyancy :	1670 LB'S	
Nominal wall thickness :	0.15"	
Cubic feet:	32.0 FT ³	
Weight:	97.0 LB.'s	
DRAWN BY : JEB	APPROVED BY :	DATE: 06-17-2014
Materials: Polyethylene encasing Expanded Foam		Type:
Part Name: 3'x8'x16"		
AutoCad 2010	PART # : EF3816	1 of 1

As with all types of materials, allowances must be made for shrinkage and changing of exact dimensions due to temperature and other conditions.