

REVISED	DATE	BY

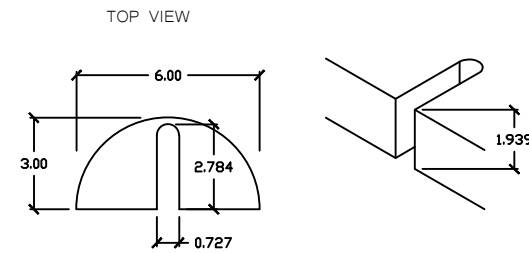
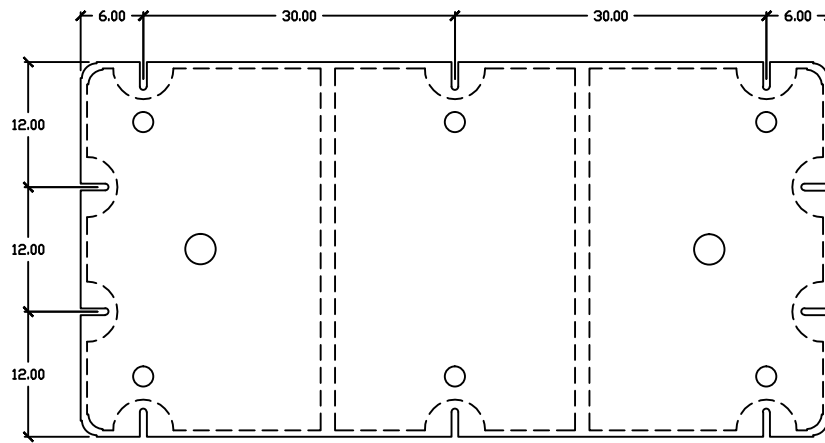
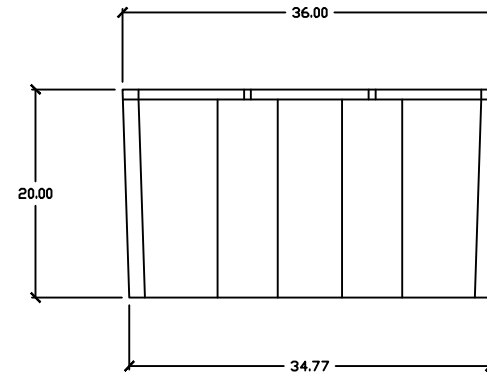
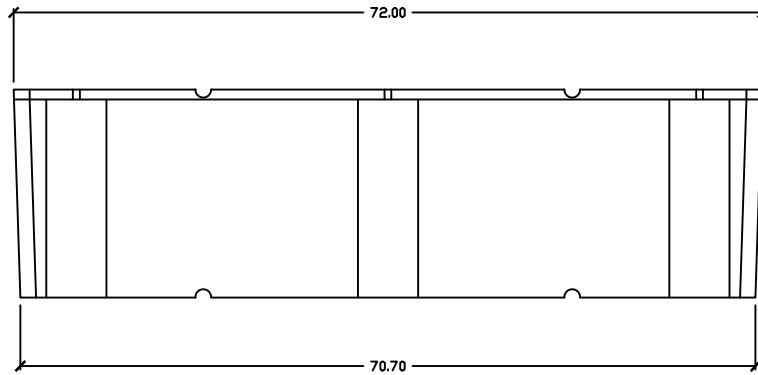

MOUNTING SLOT DETAIL
SCALE 2:1
ALL DIMS NOMINAL

Common technical specs.		
Max buoyancy :	1580 LB'S	
Nominal wall thickness :	0.15"	
Cubic feet:	30.0 FT³	
Weight:	81.0 LB.'s	
DRAWN BY : JEB	APPROVED BY :	DATE: 06-16-2014
Materials: Polyethylene encasing Expanded Foam		Type:
Part Name: 3'x6'x20"		
AutoCad 2010	PART # : EF3620	1 of 1

As with all types of materials, allowances must be made for shrinkage and changing of exact dimensions due to temperature and other conditions.